

2W power over long distance Wireless transceiver module

## Product Specification

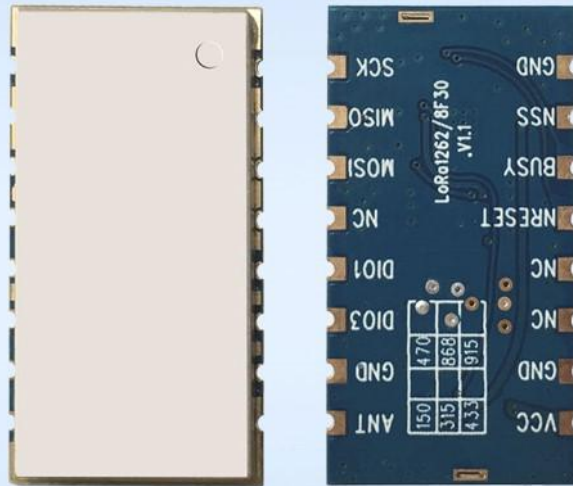

## Catalogue

1. Overview.....	- 3 -
2. Features.....	- 3 -
3. Applications.....	- 3 -
4. Internal block diagram.....	- 3 -
5. Electrical Characteristics.....	- 4 -
6. Typical application circuit.....	- 8 -
7. Rate comparison table.....	- 8 -
8. Pin definition.....	- 9 -
9. Communication Antenna.....	- 10 -
10. Mechanical Dimensions (Unit:mm) .....	- 10 -
11. Product order information.....	- 11 -
12. Common problem.....	- 11 -
Appendix 1:SMD Reflow Chart.....	- 12 -
Appendix 2:Demo Board.....	- 13 -

### Note: Revision History

Revision	Date	Comment
V1.0	2019-9-11	First release
V1.1	2019-10-15	Modify and increase some performance parameters
V2.0	2020-11	Modify description
V2.1	2020-11	Format updated

### 1. Overview

LoRa126XF30 is a wireless transceiver module with ultra-low receiving power consumption and high power, integrates Semtech RF transceiver chip SX1268/SX1262 which adopts LoRa Spread Spectrum modulation frequency hopping technique. Its communication distance and receiving sensitivity are much better than the current FSK and GFSK modulation. Multi-signal won't affect each other even in crowd frequency environment; it comes with strong anti-interference performance.

LoRa126XF30 strictly uses lead-free process for production and testing, and meets RoHS and Reach standards.

Module type	Built-in chip	Standard frequency band	Crystal
Lora1268F30	SX1268	Center 433/490 MHz Customizable 410-810 MHz	10ppm Industrial grade crystal oscillator
Lora1262F30	SX1262	Center 868/915 MHz Customizable 150-960 MHz	0.5ppm TCXO Temperature compensated crystal

### 2. Features

- Frequency Range: 433/490/868/915 MHz
- Modulation mode: LoRa、(G)FSK
- Rx Current < 5mA(7mA @TCXO)
- Data transfer rate: 0.6-300 Kbps @FSK
- Sensitivity: -148dBm @LoRa
- 0.018-62.5 Kbps @LoRa
- Maximum output power: 33dBm(2W)@6V
- 256bytes FiFo

### 3. Applications

- Industrial meter reading
- Smart city
- Environmental sensor
- Parking lot sensor management
- Warehouse management
- Health products
- Industrial automation
- Street lights
- Security products
- Agricultural sensor
- Logistics management
- Remote control

### 4. Internal block diagram

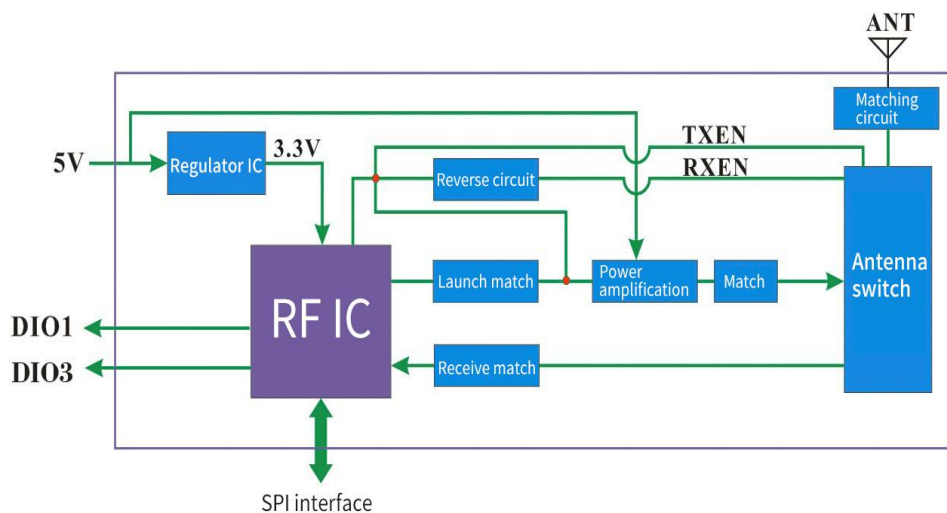

## 5. Electrical Characteristics

Parameter	Min.	Typ.	Max.	Unit	Condition
Operation Condition					
Working voltage	3	5	6.5	V	
Temperature range	-40	25	85	°C	
Current Consumption					
RX current		< 5		mA	@433MHz, 490MHz @5V
		< 7		mA	@868MHz, 915MHz @5V
TX current	550	600	650	mA	@5V 30dBm
		800	850	mA	@6V 33dBm
Sleep current		< 2		uA	@433MHz, 490MHz
		< 5		uA	@868MHz, 915MHz
RF Parameter					
Frequency range	400	433	460	MHz	@433 MHz
	470	490	510	MHz	@490 MHz
	848	868	888	MHz	@868 MHz
	900	915	940	MHz	@915 MHz
Data rate	1.2		300	Kbps	@FSK
	0.018		62.5	Kbps	@LoRa
Output power	14	31.5	32	dBm	@433MHz, 490MHz @5V
	3.0	31.5	32	dBm	@5V,@868MHz
	6	31.5	32	dBm	@5V,@915MHz
Receiving sensitivity		-122		dBm	@FSK data=1.2 Kbps Fdev=50 KHz
		-139		dBm	@Lora BW=62.5 KHz SF = 12 CR=4/5

- The transmit power of the module can be configured by software, and the corresponding values are shown in the following table:

Power level of DEMO board		0	1	2	3	4	5	6	7	8	9
Register value		-5	-2	1	4	7	10	13	16	19	22
@433MHz @5V	power(dBm)	13.6	16.1	18.9	21.6	24.1	25.3	27.8	30.3	31.4	32
	Current(mA)	220	230	240	270	320	380	470	580	660	700
@490MHz @5V	power(dBm)	12.7	15.0	17.7	20.6	23.3	26.0	28.6	30.6	31.8	32.5
	Current(mA)	190	190	210	240	290	370	490	610	710	800
@868MHz @5V	power(dBm)	3.6	6.2	9.2	12.6	16.0	19.6	23	26.2	29.6	31.8
	Current(mA)	81	92	106	130	160	214	284	372	512	640
@915MHz @5V	power(dBm)	6.1	8.9	11.8	15	18.3	21.6	24.7	27.3	31.6	31.8
	Current(mA)	85	96	116	142	182	230	310	397	610	620

- @ The output power of the 433MHz frequency band module under different working voltages is shown in the figure below:

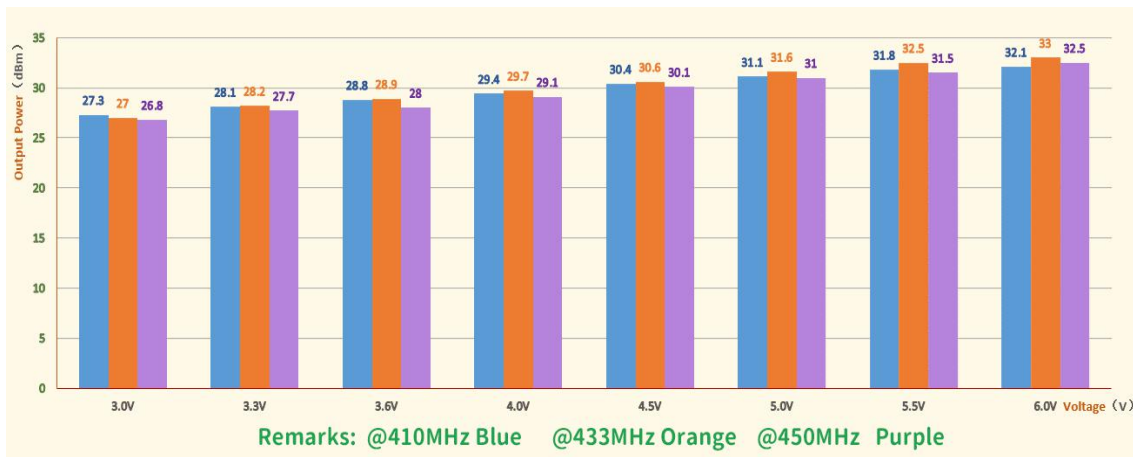

- @The output power of the 490MHz frequency band module under different working voltages is shown in the figure below:

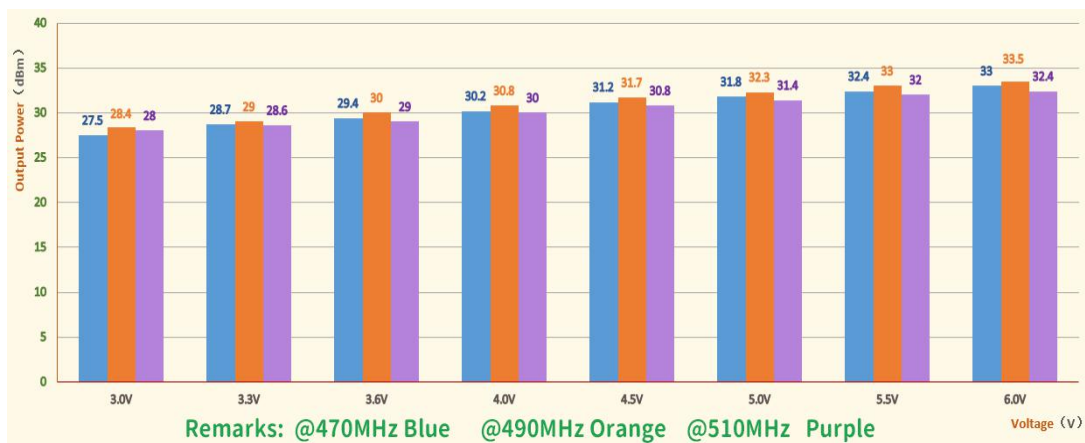

- @Under different working voltages of the 868MHz frequency band module, the output power of the module is shown in the figure below:

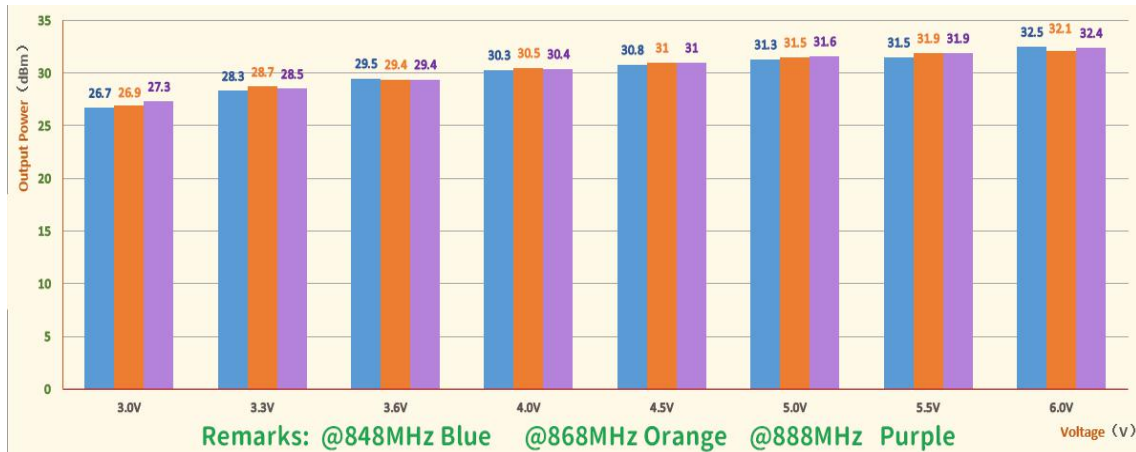

- @The output power of the 915MHz frequency band module under different working voltages is shown in the figure below:

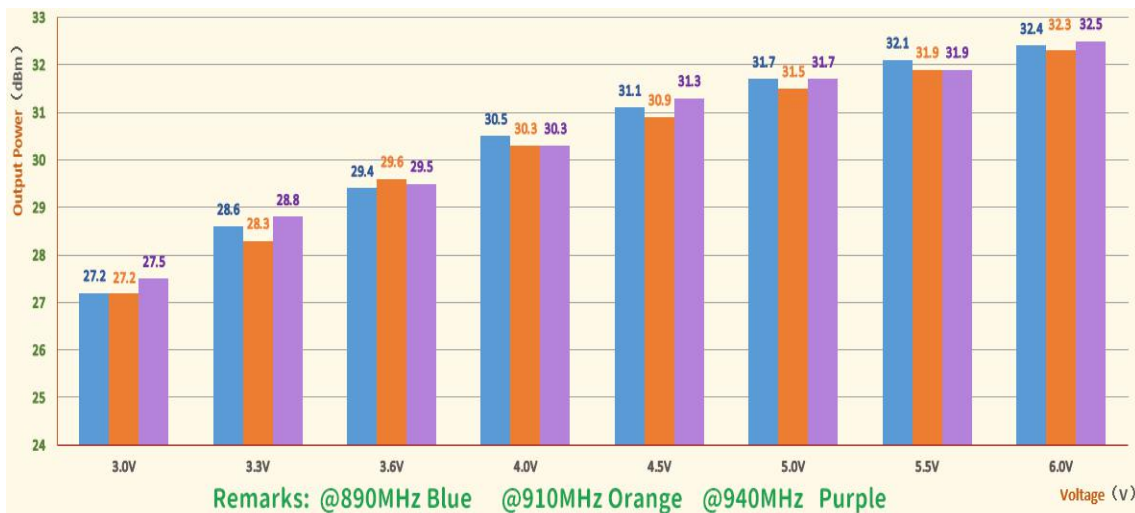

- @Under different working voltages of the 433MHz band module, the emission current value of the module is shown in the figure below:

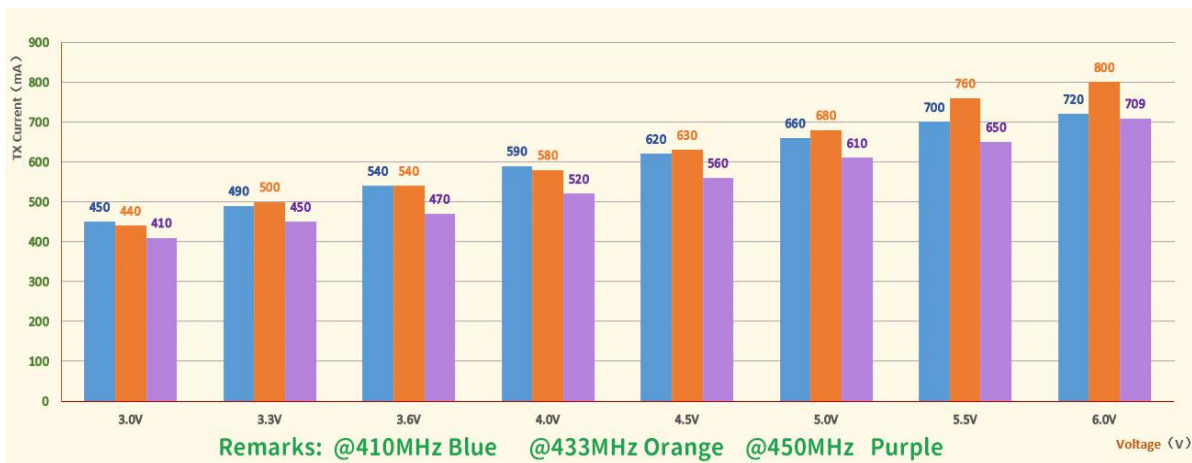

- @490MHz frequency band module under different working voltage, the module's emission current value is shown in the following figure:

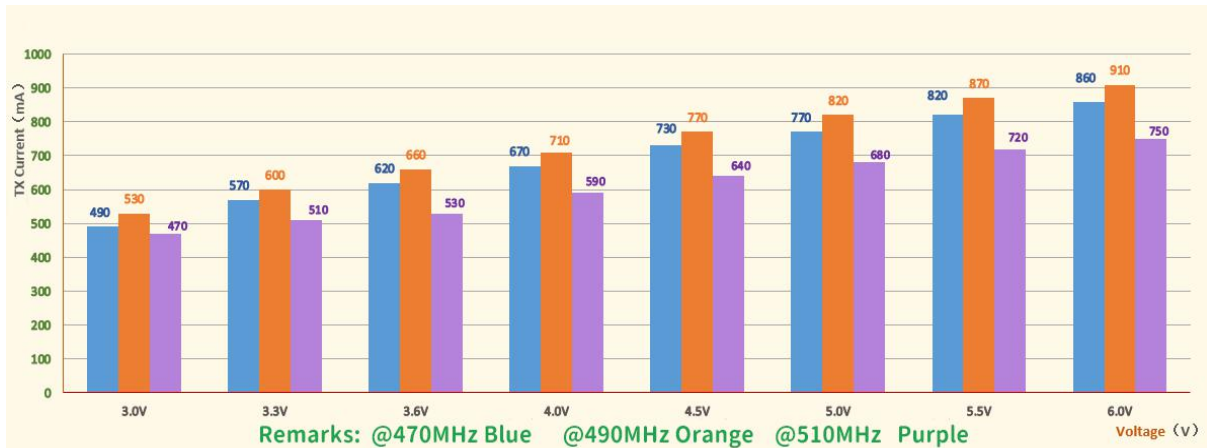

- @868MHz frequency band module under different working voltage, the emission current value of the module is shown in the figure below:

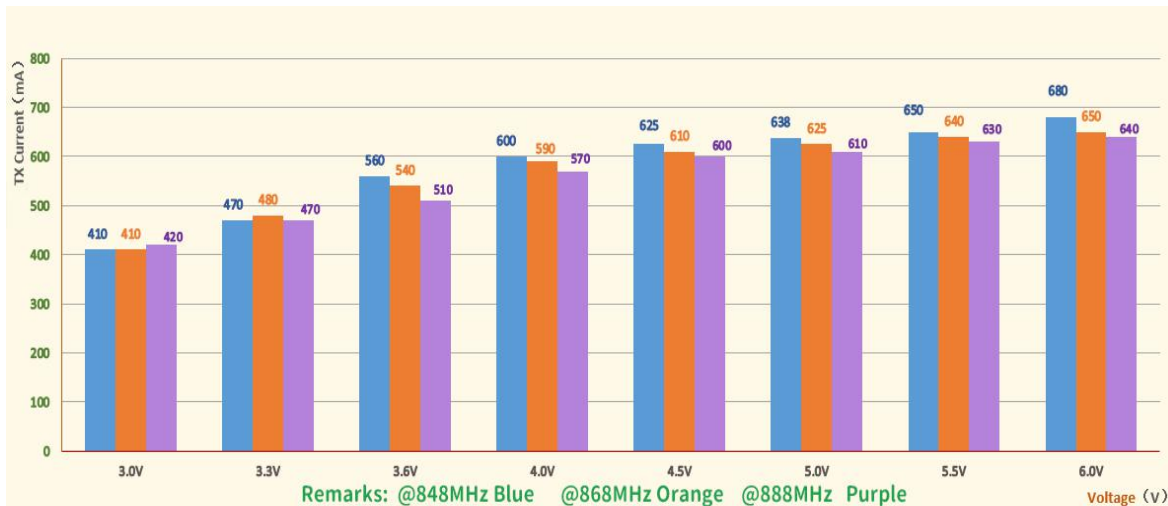

- @915MHz frequency band module under different working voltage, the module's emission current value is as shown in the figure below

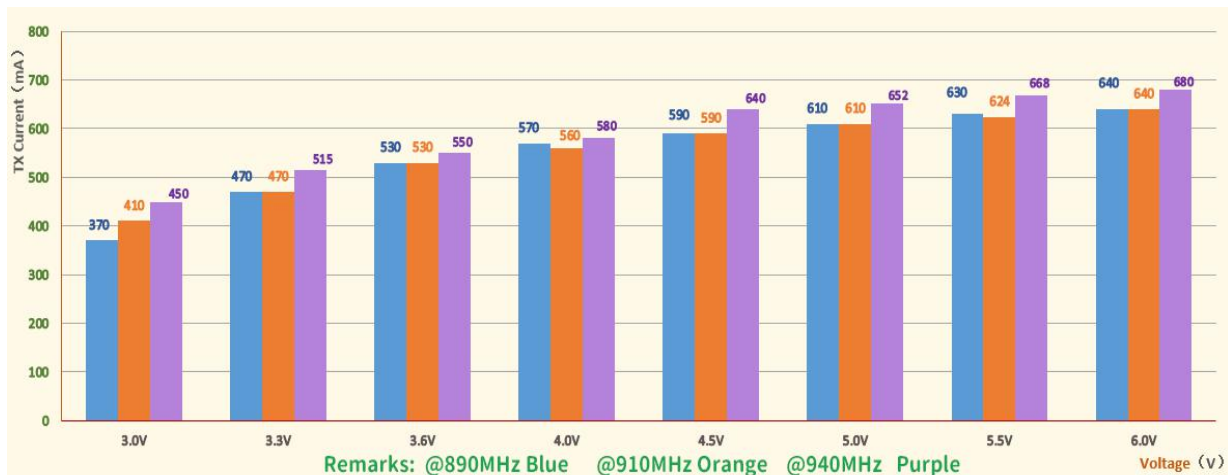



6. Typical application circuit

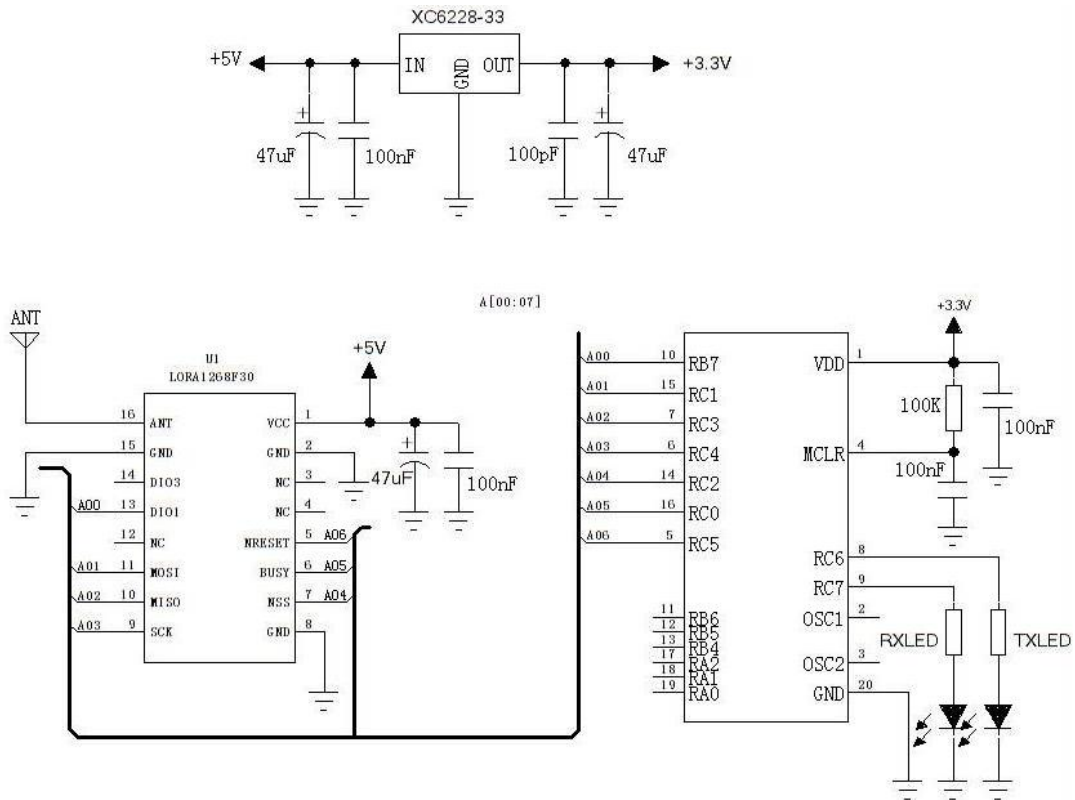

7. Rate comparison table

SignalBandWidth	SpreadingFactor	Sensitivity(dbm)	ActualBandRate(bps)
62.5kHz	SF=7	-126	2169
62.5kHz	SF=8	-129	1187
62.5kHz	SF=9	-132	656
62.5kHz	SF=10	-135	296
62.5kHz	SF=11	-137	164
62.5kHz	SF=12	-139	91
125kHz	SF=7	-123	4338
125kHz	SF=8	-126	2375
125kHz	SF=9	-129	1312
125kHz	SF=10	-132	733
125kHz	SF=11	-133	328
125kHz	SF=12	-136	183
250kHz	SF=7	-120	8676
250kHz	SF=8	-123	4750
250kHz	SF=9	-125	2624
250kHz	SF=10	-128	1466
250kHz	SF=11	-130	778
250kHz	SF=12	-133	366
500kHz	SF=7	-118	17353
500kHz	SF=8	-121	9501
500kHz	SF=9	-124	5249
500kHz	SF=10	-127	2932
500kHz	SF=11	-129	1557
500kHz	SF=12	-130	830



8. Pin definition

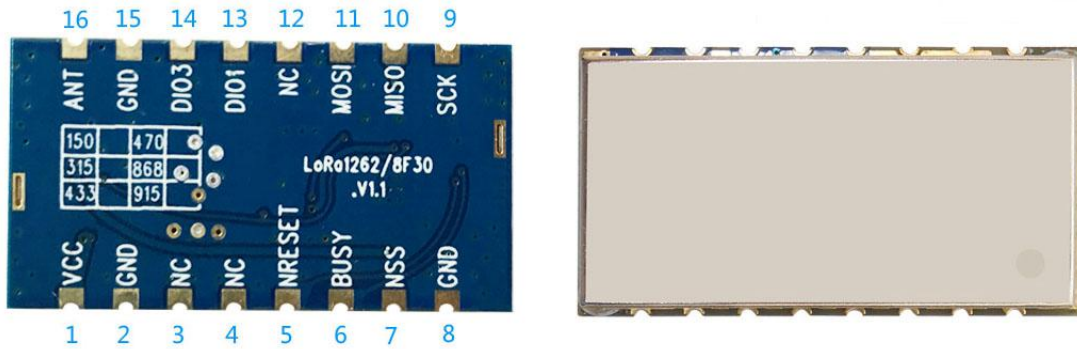

Pin NO.	Pin name	Description
1	VCC	Power supply
2	GND	power ground
3,4,12	NC	Empty
5	NRESET	power ground
6	BUSY	Used for status indication, see chip data for details.
7	NSS	SPI enable
8	GND	power ground
9	SCK	Serial clock for SPI interface
10	MISO	SPI Output for SPI data
11	MOSI	SPI Input for SPI data
13	DIO1	Digital I/O, customizable
14	DIO3	Digital I/O, customizable
15	GND	power ground
16	ANT	Connect with 50 ohm coaxial antenna

Note: In LAYOUT, the GND (pin 15) next to the ANT (pin 16) pin cannot be directly connected to the ground of the system. It can be connected to the GND of the external SMA socket. The trace between the antenna socket and the module antenna pin should be as short as possible, and the recommended thickness is >1mm. As shown below:

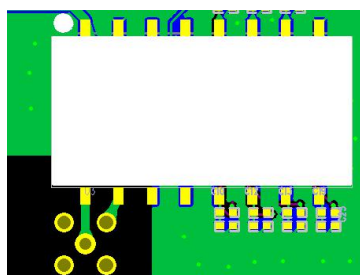

## 9. Communication Antenna

Antenna is very important for RF communication, its performance will affect the communication directly. Module needs antenna in 50ohm. Common antennas have spring antennas, and external antennas can also be transferred via SMA, Users can order accordingly. To ensure module in the best performance, we suggest to use the our antenna.

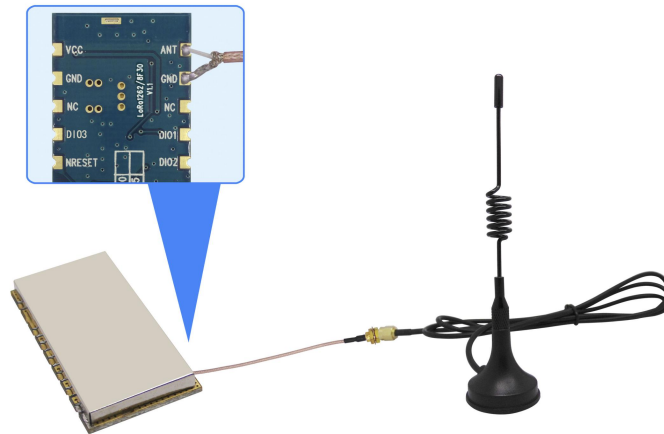

★ To ensure modules get the best performance, user must obey the following principles when using the antennas:

- Put the antenna away from the ground and obstacles as possible as you could;
- If you choose the sucker antenna, pull straight the lead wire as possible as it can be, the sucker under arches should be attached on the metal object.

## 10. Mechanical Dimensions (Unit:mm)

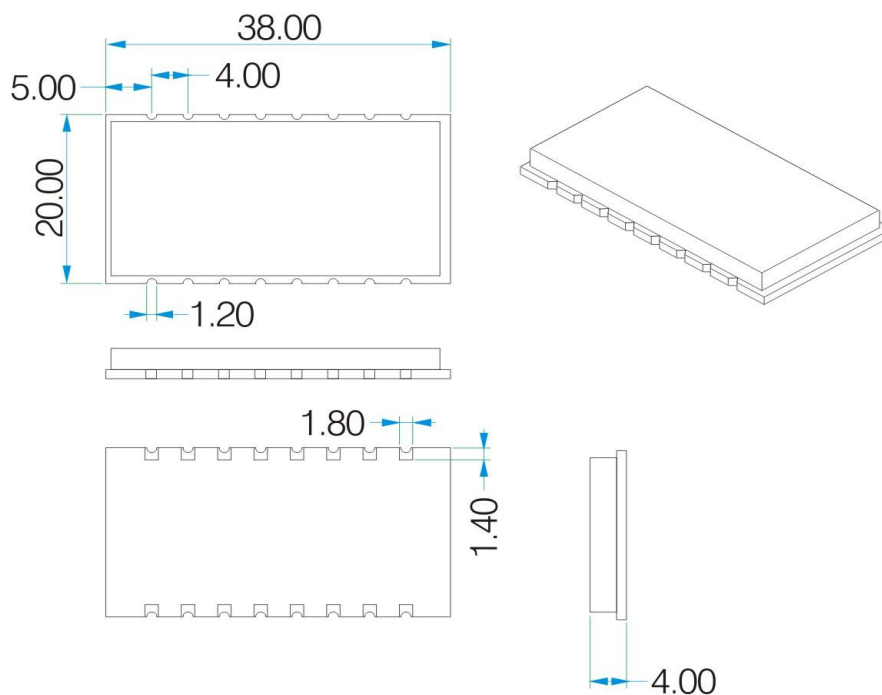

## 11. Product order information

LoRa1268F30-433

Module model

Frequency

For example: If the customer needs 490MHz Frequency, the order no. shall be LoRa1268F30-490.

Currently LORAF30 products have the following models:

Product Name	Description
LoRa1268F30-433	The center frequency is 433MHz
LoRa1268F30-490	The center frequency is 490MHz
LoRa1262F30-868	The center frequency is 868MHz
LoRa1262F30-915	The center frequency is 915MHz

## 12. Common problem

- a) Why can't the normal communication between the modules?
  - 1) The power connection is wrong and the module is not working normally;
  - 2) Check whether the frequency bands of each module and other RF parameters are consistent;
  - 3) Whether the module is damaged.
- b) Why is the transmission distance not far?
  - 1) The power supply ripple is too large;
  - 2) The antenna type is not matched or installed incorrectly;
  - 3) Surrounding co-channel interference;

The surrounding environment is harsh and there are strong interference sources.

### Appendix 1:SMD Reflow Chart

We recommend you should obey the IPC related standards in setting the reflow profile:

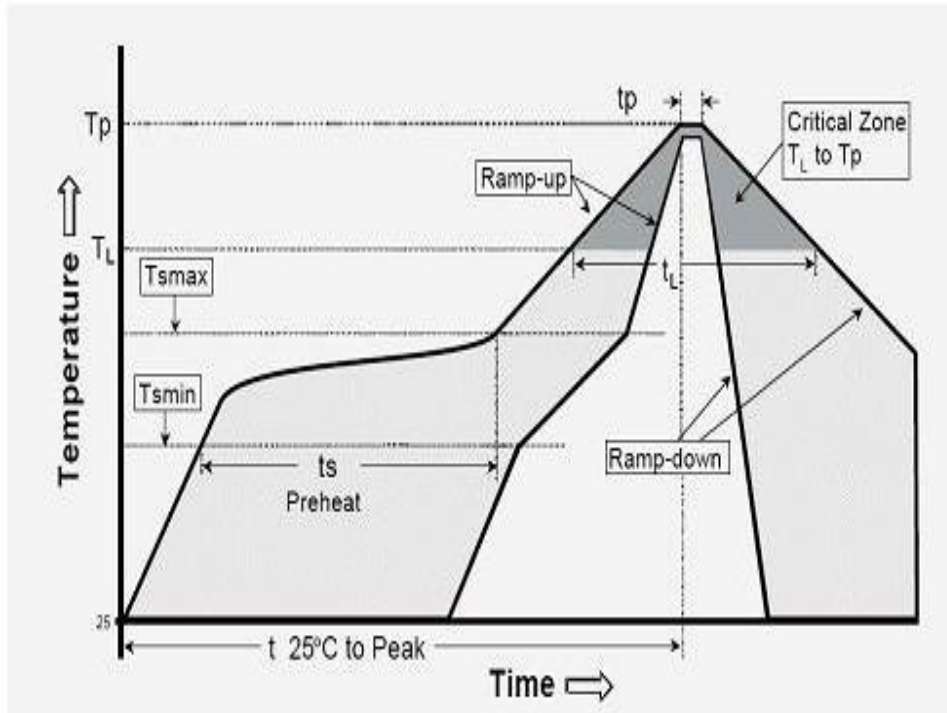

IPC/JEDEC J-STD-020B the condition for lead-free reflow soldering	big size components (thickness >=2.5mm)
The ramp-up rate (T <sub>l</sub> to T <sub>p</sub> )	3°C/s (max. )
preheat temperature	
- Temperature minimum (T <sub>min</sub> )	150°C
- Temperature maximum (T <sub>max</sub> )	200°C
- preheat time (t <sub>s</sub> )	60~180s
Average ramp-up rate(T <sub>max</sub> to T <sub>p</sub> )	3°C/s (Max. )
- Liquidous temperature(T <sub>L</sub> )	217°C
- Time at liquidous(t <sub>L</sub> )	60~150 second
peak temperature(T <sub>p</sub> )	245+/-5°C

## Appendix 2: Demo Board

The module is equipped with a standard DEMO board for customer to debug the program and test distance. The power supply voltage range: 3.3V~6.0V. It shows as below:

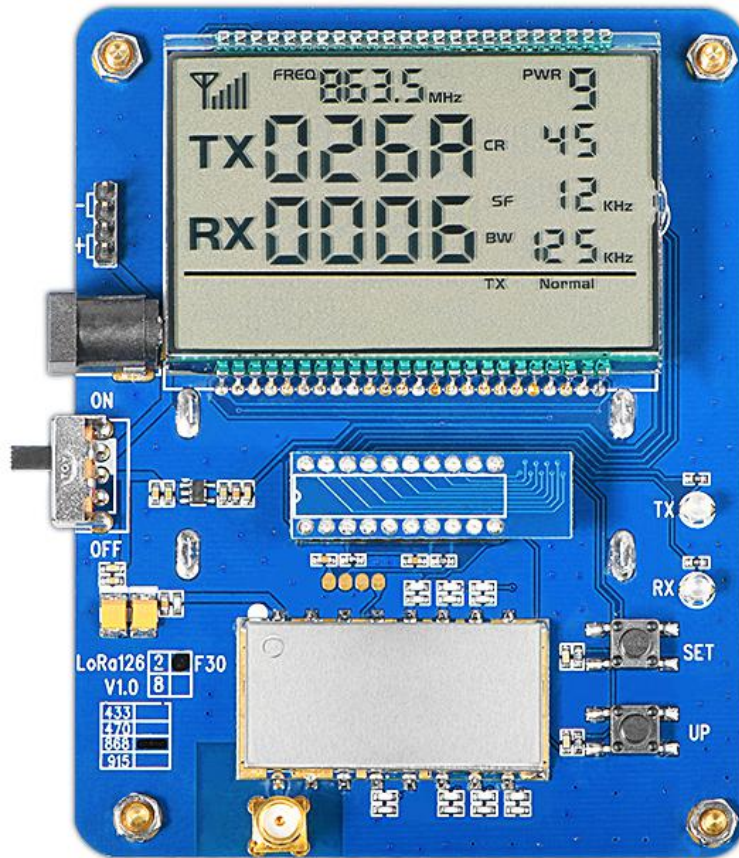

The LCD Full Segment is as below:

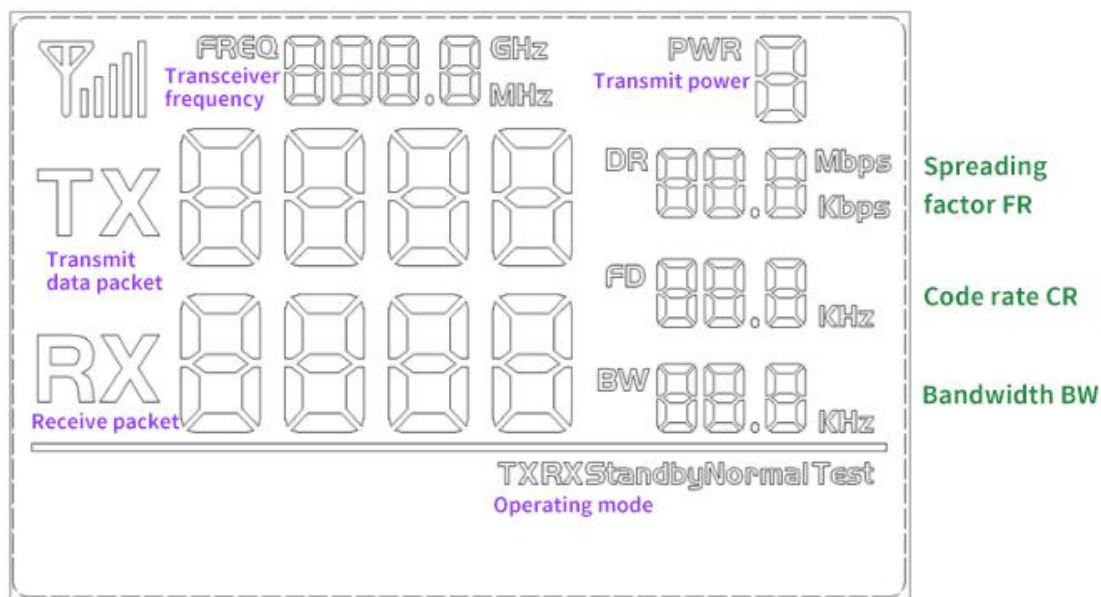

The users can set the parameters of the RF module such as frequency /transmitter power / transmission data rate through the buttons.

➤ **Working Mode:**

- 1) Tx normal mode: send data packets regularly (In the setting mode, data packets will not be sent);
- 2) Rx normal mode: Power on and enter the receive state, receive data packets, and then send out the correctly received data packets;
- 3) Tx Test Mode: RF module continuously transmit signal;
- 4) Rx Test Mode: RF module is always in Rx mode;
- 5) Standby Mode: RF module is always in standby state.

➤ **Button Operation:**

- 1) [SET] Button

Press the key to enter the setting mode. If the last parameter is set, the key will exit the setting mode.

- 2) UP /Down Button

In setting mode, press to modify the corresponding setting parameters.

Note: The DEMO board has FLASH memory inside, all the setting parameters will behave automatically and keep unchanged even power-off.